

GND N L2 L1

LEGEND	
	- 1/4" QUICK CONNECT
	- 1/4" QUICK CONNECT PIGGYBACK
	- FORK CONNECTOR
	- RING CONNECTOR
	- SOCKET CONNECTOR
	- PIN CONNECTOR

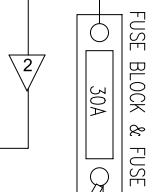

# 33-0022A-R6

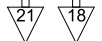
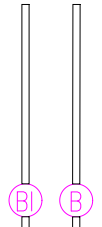
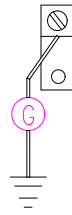
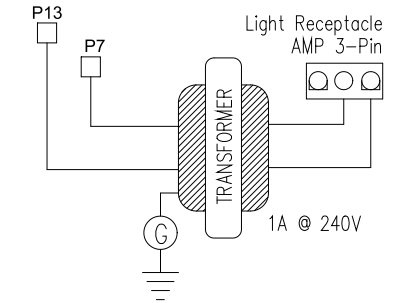
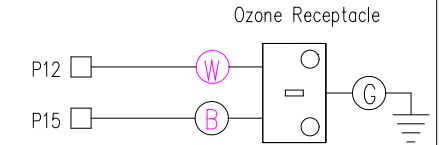
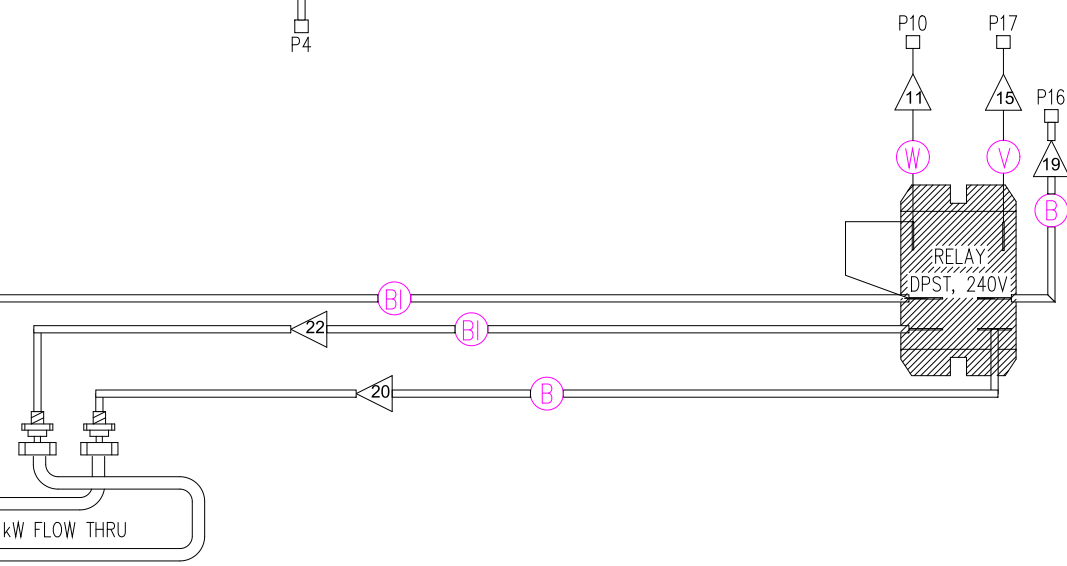
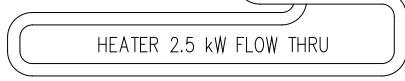
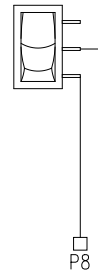
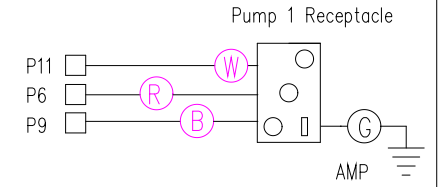
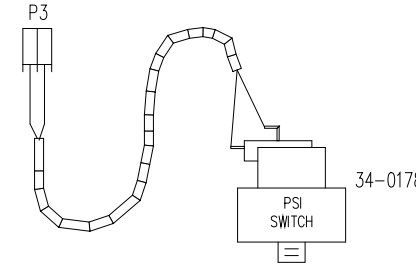
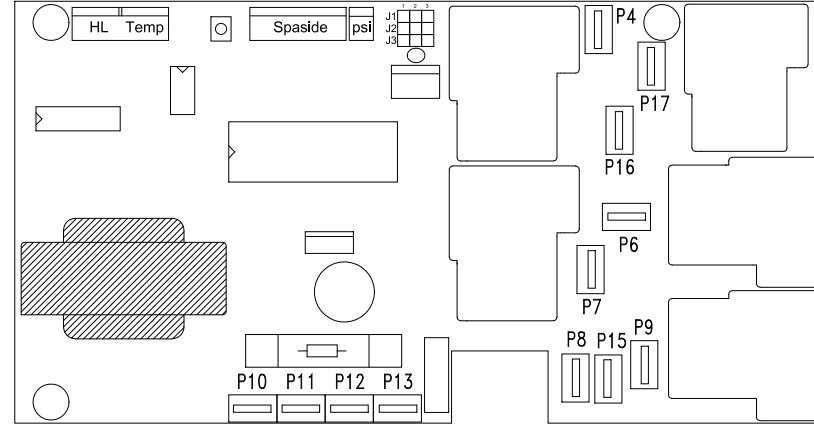

**HYDRO-QUIP**  
CORONA, CA (909) 273-7575

Manufacture Notes:

Approved By:

Dwg. No.  
**E200A0-AKQY68-G**

Drawn	Rev
BH	0
Date	11.11.02
Diagram No.	<b>4116-R</b>

Wire Color Code	
B - Black	G - Green
Br - Brown	Bl - Blue
R - Red	V - Violet
O - Orange	W - White
Y - Yellow	Gr - Gray